

The logo for KOLAXO INSTRUMENTS features the word "KOLAXO" in a large, bold, green sans-serif font. A green curved line arches over the letters "O", "L", and "A". Below "KOLAXO", the word "INSTRUMENTS" is written in a smaller, black, all-caps sans-serif font, with wide letter spacing.

# KOLAXO INSTRUMENTS

 [www.kolaxoinstruments.com](http://www.kolaxoinstruments.com)

A collection of surgical instruments, including forceps and scissors, are arranged on a blue textured surface. A green semi-transparent box is overlaid on the top left, containing the text.

# ABOUT US

Our industry knowledge and decisive craftsmanship are keys to our high-quality surgical instruments. We consistently offer the best surgical instruments by adhering to all the international standards that make us the unwavering priority of surgeons around the globe.

# Artery Forceps

## Adson Artery Forceps

Box joint, 180mm long

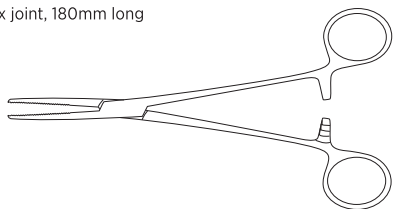

### Serrated jaws

| Code       | Description |
|------------|-------------|
| SC-GI/034  | Straight    |
| SC-GI/034a | Curved      |

### 1-2 teeth

| Code       | Description |
|------------|-------------|
| SC-GI/034b | Straight    |
| SC-GI/034c | Curved      |

## Cushing Artery Forceps

Box joint, fine, half serrated jaws, 140mm long

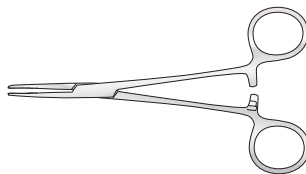

| Code      | Description |
|-----------|-------------|
| SC-GI/001 | Straight    |
| SC-GI/002 | Curved      |

## Cairns Artery Forceps

Box joint, half serrated jaws  
145mm long

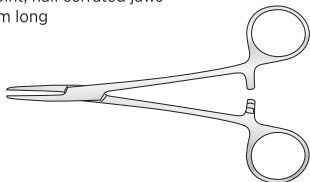

### Serrated jaws

| Code      | Description |
|-----------|-------------|
| SC-GI/415 | Straight    |

### 1-2 teeth

| Code      | Description    |
|-----------|----------------|
| SC-GI/020 | Curved         |
| SC-GI/021 | Curved to side |

## Dunhill Artery Forceps

Box joint, fine serrations

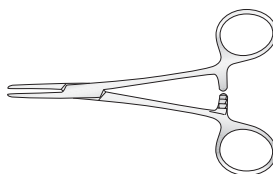

### Straight

| Code       | Description |
|------------|-------------|
| SC-GI/065  | 135mm long  |
| SC-GI/065a | 190mm long  |

### Curved

| Code      | Description |
|-----------|-------------|
| SC-GI/043 | 135mm long  |
| SC-GI/468 | 180mm long  |

## Crile Artery Forceps

Box joint, serrated jaws

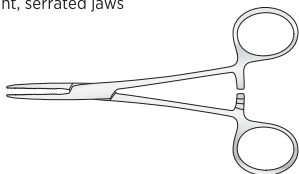

### Straight

| Code       | Description |
|------------|-------------|
| SC-GI/014  | 140mm long  |
| SC-GI/014a | 160mm long  |

### Curved

| Code       | Description |
|------------|-------------|
| SC-GI/015  | 140mm long  |
| SC-GI/015a | 160mm long  |

## Lawson Tait Artery Forcep

Box joint, straight jaw

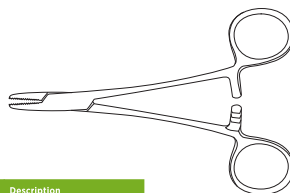

| Code         | Description |
|--------------|-------------|
| SC-GI/SH5924 | 140mm long  |

## Halstead Mosquito Forceps

Standard pattern, haemostatic, box joint

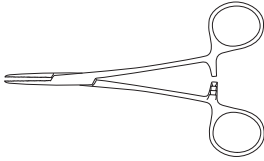

### Serrated jaw

| Code      | Description             |
|-----------|-------------------------|
| SC-GI/007 | Straight 125mm long     |
| SC-GI/008 | Curved 125mm long       |
| SC-GI/009 | Fully curved 125mm long |

### 1-2 teeth

| Code      | Description         |
|-----------|---------------------|
| SC-GI/010 | Straight 125mm long |
| SC-GI/012 | Straight 190mm long |
| SC-GI/011 | Curved 125mm long   |
| SC-GI/013 | Curved 190mm long   |

### Micro, 100mm long

| Code      | Description         |
|-----------|---------------------|
| SC-GI/003 | Straight, serrated  |
| SC-GI/004 | Curved, serrated    |
| SC-GI/005 | Straight, 1-2 teeth |
| SC-GI/006 | Curved, 1-2 teeth   |

## Kelly Artery Forceps

Box joint, half serrated jaws



### Straight

| Code      | Description |
|-----------|-------------|
| SC-GI/022 | 140mm long  |
| SC-GI/023 | 160mm long  |

### Curved

| Code      | Description |
|-----------|-------------|
| SC-GI/024 | 140mm long  |
| SC-GI/025 | 160mm long  |

## Fraser Kelly Artery Forceps Curved

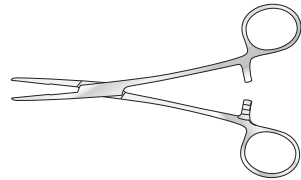

### Straight

| Code       | Description |
|------------|-------------|
| SC-GI/468a | 180mm       |

## Heiss Artery Forceps

Box joint, 205mm long

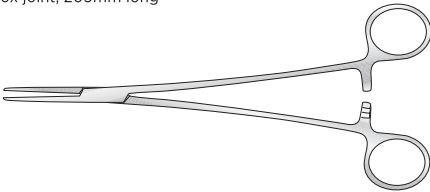

### Serrated jaws

| Code      | Description |
|-----------|-------------|
| SC-GI/016 | Straight    |
| SC-GI/017 | Curved      |

### 1-2 teeth

| Code       | Description |
|------------|-------------|
| SC-GI/016a | Straight    |
| SC-GI/017b | Curved      |

## Kocher Artery Forceps

Box joint, 1-2 teeth

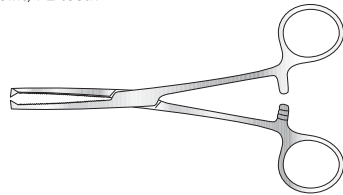

### Straight

| Code      | Description |
|-----------|-------------|
| SC-GI/052 | 130mm long  |
| SC-GI/053 | 150mm long  |
| SC-GI/054 | 180mm long  |
| SC-GI/055 | 200mm long  |
| SC-GI/056 | 230mm long  |

### Curved

| Code      | Description |
|-----------|-------------|
| SC-GI/057 | 150mm long  |
| SC-GI/058 | 180mm long  |
| SC-GI/059 | 200mm long  |
| SC-GI/060 | 230mm long  |

# Artery Forceps

## Moynihan Artery Forceps

Box joint, half-serrated jaws

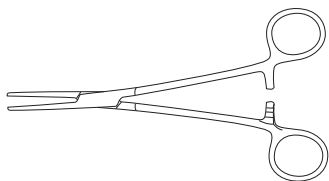

### Straight

| Code      | Description |
|-----------|-------------|
| SC-GI/018 | 145mm long  |
| SC-GI/068 | 180mm long  |

### Curved

| Code      | Description |
|-----------|-------------|
| SC-GI/019 | 145mm long  |
| SC-GI/069 | 180mm long  |

## Rochester-Pean Artery Forceps

Box joint

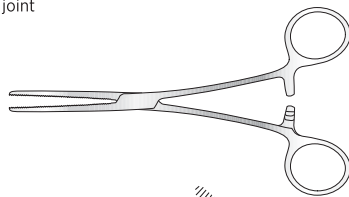

### Straight

| Code      | Description |
|-----------|-------------|
| SC-GI/044 | 165mm long  |
| SC-GI/045 | 190mm long  |
| SC-GI/046 | 205mm long  |
| SC-GI/047 | 240mm long  |

### Curved

| Code      | Description |
|-----------|-------------|
| SC-GI/048 | 165mm long  |
| SC-GI/049 | 180mm long  |
| SC-GI/050 | 205mm long  |
| SC-GI/051 | 240mm long  |

## Roberts Artery Forceps

Screw joint, curved on flat, serrated

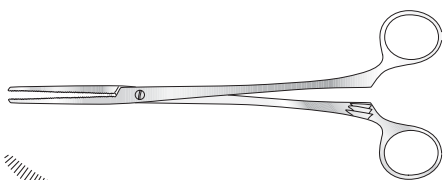

| Code      | Description |
|-----------|-------------|
| SC-GI/070 | 230mm long  |

## Spencer Wells Artery Forceps

Box joint, serrated jaws

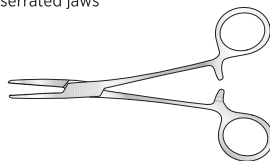

### Straight

| Code      | Description |
|-----------|-------------|
| SC-GI/035 | 127mm long  |
| SC-GI/036 | 152mm long  |
| SC-GI/037 | 177mm long  |
| SC-GI/038 | 203mm long  |

### Curved

| Code      | Description |
|-----------|-------------|
| SC-GI/039 | 127mm long  |
| SC-GI/040 | 152mm long  |
| SC-GI/041 | 177mm long  |
| SC-GI/042 | 203mm long  |

OTHER SIZES AVAILABLE

## Dandy Artery Forceps

Box joint, curved in plane

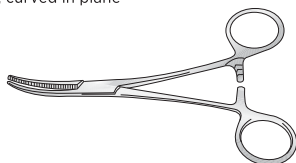

| Code      | Description |
|-----------|-------------|
| SC-GI/076 | 140mm long  |



## Carmalt Angiotribe Forceps

Box joint, atraumatic, light pattern

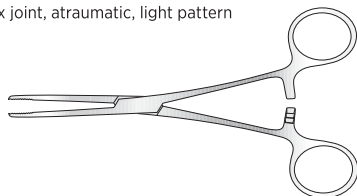

### Straight

| Code      | Description |
|-----------|-------------|
| SC-GI/062 | 165mm long  |
| SC-GI/063 | 200mm long  |
| SC-GI/064 | 230mm long  |

### Curved

| Code      | Description |
|-----------|-------------|
| SC-GI/061 | 165mm long  |

## Dieffenbach Bulldog Clamp



### Straight, serrated

| Code       | Description               |
|------------|---------------------------|
| SC-GI/112  | 1.2mm fine jaw, 40mm long |
| SC-GI/113  | 1.2mm fine jaw, 45mm long |
| SC-GI/108  | 1.8mm jaw, 30mm long      |
| SC-GI/109  | 1.8mm jaw, 35mm long      |
| SC-GI/110  | 2.5mm jaw, 40mm long      |
| SC-GI/111  | 2.5mm jaw, 45mm long      |
| SC-GI/107  | 6mm heavy jaw, 60mm long  |
| SC-GI/455  | 20mm jaw, 75mm long       |
| SC-GI/455a | 30mm jaw, 85mm long       |
| SC-GI/455b | 45mm jaw, 105mm long      |
| SC-GI/455c | 65mm jaw, 120mm long      |

### Straight, plain

| Code      | Description               |
|-----------|---------------------------|
| SC-GI/129 | 1.2mm fine jaw, 40mm long |
| SC-GI/131 | 1.2mm fine jaw, 45mm long |
| SC-GI/121 | 1.8mm jaw, 30mm long      |
| SC-GI/123 | 1.8mm jaw, 35mm long      |
| SC-GI/125 | 2.5mm jaw, 40mm long      |
| SC-GI/127 | 2.5mm jaw, 45mm long      |

### Curved, serrated

| Code       | Description               |
|------------|---------------------------|
| SC-GI/119  | 1.2mm fine jaw, 40mm long |
| SC-GI/120  | 1.2mm fine jaw, 45mm long |
| SC-GI/115  | 1.8mm jaw, 30mm long      |
| SC-GI/116  | 1.8mm jaw, 35mm long      |
| SC-GI/117  | 2.5mm jaw, 40mm long      |
| SC-GI/118  | 2.5mm jaw, 45mm long      |
| SC-GI/114  | 6mm heavy jaw, 60mm long  |
| SC-GI/456  | 20mm jaw, 75mm long       |
| SC-GI/456a | 30mm jaw, 85mm long       |
| SC-GI/456b | 45mm jaw, 105mm long      |
| SC-GI/456c | 65mm jaw, 120mm long      |

### Curved, plain

| Code      | Description               |
|-----------|---------------------------|
| SC-GI/130 | 1.2mm fine jaw, 40mm long |
| SC-GI/132 | 1.2mm fine jaw, 45mm long |
| SC-GI/122 | 1.8mm jaw, 30mm long      |
| SC-GI/124 | 1.8mm jaw, 35mm long      |
| SC-GI/126 | 2.5mm jaw, 40mm long      |
| SC-GI/128 | 2.5mm jaw, 45mm long      |

## Blalock Bulldog Clamp

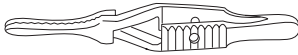

### Serrated, with hole in handle

#### Straight

| Code      | Description         |
|-----------|---------------------|
| SC-GI/480 | 11mm jaw, 38mm long |
| SC-GI/482 | 14mm jaw, 48mm long |
| SC-GI/493 | 17mm jaw, 60mm long |
| SC-GI/481 | 27mm jaw, 70mm long |

#### Curved

| Code      | Description         |
|-----------|---------------------|
| SC-GI/478 | 11mm jaw, 38mm long |
| SC-GI/479 | 14mm jaw, 48mm long |
| SC-GI/491 | 17mm jaw, 60mm long |
| SC-GI/492 | 27mm jaw, 70mm long |

### Plain, with hole in handle

#### Straight

| Code      | Description         |
|-----------|---------------------|
| SC-GI/486 | 11mm jaw, 38mm long |
| SC-GI/487 | 14mm jaw, 48mm long |
| SC-GI/488 | 17mm jaw, 60mm long |
| SC-GI/489 | 27mm jaw, 70mm long |

#### Curved

| Code      | Description         |
|-----------|---------------------|
| SC-GI/483 | 11mm jaw, 38mm long |
| SC-GI/484 | 14mm jaw, 48mm long |
| SC-GI/485 | 17mm jaw, 60mm long |
| SC-GI/490 | 27mm jaw, 70mm long |

# Spring Forceps

## Adsons Dissecting Forceps

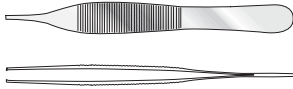

127mm long

| Code      | Description                  |
|-----------|------------------------------|
| SC-GI/257 | 1-2 teeth                    |
| SC-GI/258 | Lightweight, micro           |
| SC-GI/259 | Serrated                     |
| SC-GI/260 | Serrated, lightweight, micro |

## Block End Dissecting Forceps

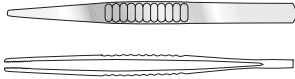

Serrated

| Code       | Description |
|------------|-------------|
| SC-GI/255  | 127mm long  |
| SC-GI/256  | 152mm long  |
| SC-GI/256a | 203mm long  |

## Bonney Dissecting Forceps

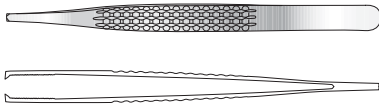

178mm long

| Code      | Description         |
|-----------|---------------------|
| SC-GI/267 | Serrated, 1-2 teeth |
| SC-GI/268 | 1-2 teeth           |

## Charnley-McIndoe Dissecting Forceps

150mm long

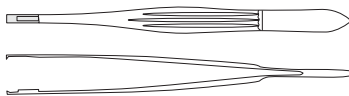

| Code        | Description |
|-------------|-------------|
| SC-OR/N045a | 2-3 teeth   |

## DeBakey Atraumatic Dissecting Forceps

Straight, atraumatic jaws

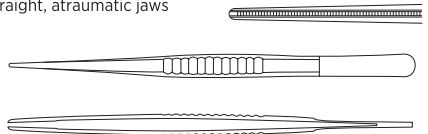

1.5mm

| Code       | Description |
|------------|-------------|
| SC-GI/238a | 150mm long  |
| SC-GI/240a | 240mm long  |

2.5mm

| Code       | Description |
|------------|-------------|
| SC-GI/238b | 150mm long  |
| SC-GI/240b | 240mm long  |

2mm

| Code      | Description |
|-----------|-------------|
| SC-GI/239 | 150mm long  |
| SC-GI/241 | 180mm long  |

2.8mm

| Code       | Description |
|------------|-------------|
| SC-GI/238c | 150mm long  |
| SC-GI/240c | 240mm long  |
| SC-GI/241c | 180mm long  |

## Dissecting Forceps

Turnover end, serrated jaws

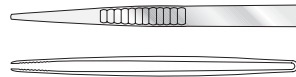

| Code      | Description |
|-----------|-------------|
| SC-GI/242 | 127mm long  |
| SC-GI/243 | 152mm long  |

| Code      | Description |
|-----------|-------------|
| SC-GI/244 | 178mm long  |
| SC-GI/245 | 203mm long  |

## Dunhill Dissecting Forceps

Light, fine serrated jaws



| Code      | Description |
|-----------|-------------|
| SC-GI/457 | 145mm long  |

## Fredrick Coole Dissecting Forceps

Extra fine serrated jaws



125mm long

| Code      | Description |
|-----------|-------------|
| SC-GI/066 | Straight    |
| SC-GI/067 | Curved      |

## Gillies Dissecting Forceps

1-2 teeth

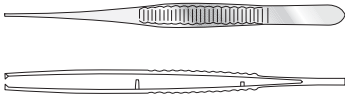

| Code      | Description |
|-----------|-------------|
| SC-PL/052 | 152mm long  |

## McIndoe Dissecting Forceps

152mm long

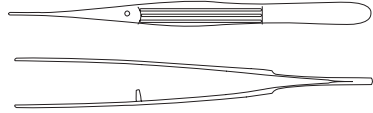

| Code      | Description |
|-----------|-------------|
| SC-GI/476 | Serrated    |
| SC-GI/477 | 1-2 teeth   |

## Jackson Burrows Dissecting Forceps

140mm long

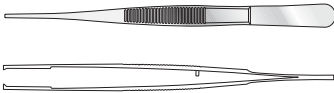

| Code        | Description                  |
|-------------|------------------------------|
| SC-OR/N037  | Tongue and groove, 1-2 teeth |
| SC-OR/N037a | Tongue and groove only       |

## McIndoe Modified Dissecting Forceps

152mm long, 1mm tip, modified for fine powerful dissection with strong action tip



| Code    | Description |
|---------|-------------|
| SH/5961 | Serrated    |

## Jean Dissecting Forceps

Serrated jaws, 140mm long

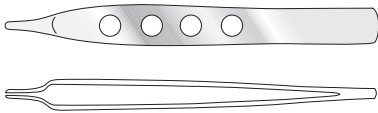

| Code      | Description           |
|-----------|-----------------------|
| SC-GI/269 | Fine                  |
| SC-GI/270 | 1-2 teeth             |
| SC-GI/271 | 2-3 teeth, 178mm long |

## Treves Dissecting Forceps

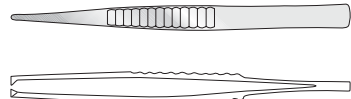

1-2 teeth

| Code      | Description |
|-----------|-------------|
| SC-GI/251 | 127mm long  |
| SC-GI/252 | 152mm long  |

2-3 teeth

| Code      | Description |
|-----------|-------------|
| SC-GI/253 | 127mm long  |
| SC-GI/254 | 152mm long  |

## Lanes Dissecting Forceps

1-2 teeth on serrated jaws, 140mm long



| Code      | Description |
|-----------|-------------|
| SC-GI/246 | 127mm long  |
| SC-GI/247 | 152mm long  |
| SC-GI/248 | 178mm long  |

| Code      | Description           |
|-----------|-----------------------|
| SC-GI/249 | 2-3 teeth, 178mm long |
| SC-GI/250 | 2-3 teeth 203mm long  |

## Waugh Dissecting Forceps

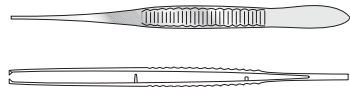

Fine, serrated

| Code      | Description |
|-----------|-------------|
| SC-GI/261 | 152mm long  |
| SC-GI/262 | 178mm long  |
| SC-GI/263 | 203mm long  |

Fine, 1-2 teeth

| Code      | Description |
|-----------|-------------|
| SC-GI/264 | 152mm long  |
| SC-GI/265 | 178mm long  |
| SC-GI/266 | 203mm long  |



# Tissue Forceps

## Allis Tissue Forceps

Box joint

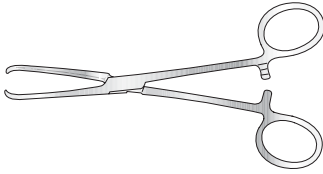

150mm long

| Code      | Description |
|-----------|-------------|
| SC-GI/272 | 3-4 teeth   |
| SC-GI/273 | 4-5 teeth   |

190mm long

| Code      | Description |
|-----------|-------------|
| SC-GI/414 | 5-6 teeth   |

## Duval Tissue Forceps

Box joint

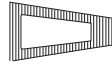
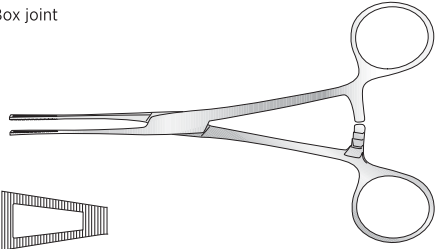

| Code      | Description           |
|-----------|-----------------------|
| SC-GI/279 | 13mm wide, 203mm long |

## Littlewood Tissue Forceps

Box joint, 2-3 teeth

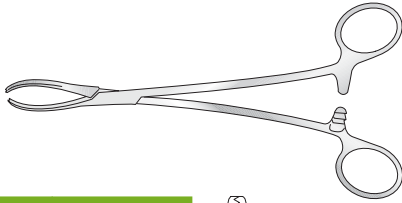

| Code      | Description |
|-----------|-------------|
| SC-GI/275 | 190mm long  |

## Lane Tissue Forceps

Box joint, 1-2 teeth, fenestrated

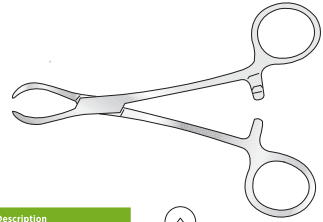

| Code      | Description |
|-----------|-------------|
| SC-GI/280 | 127mm long  |
| SC-GI/281 | 152mm long  |
| SC-GI/282 | 197mm long  |

## Babcock Tissue Forceps

Box joint, serrated jaws

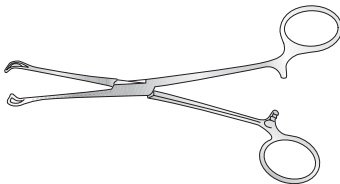

| Code      | Description |
|-----------|-------------|
| SC-GI/276 | 160mm long  |
| SC-GI/277 | 200mm long  |
| SC-GI/278 | 230mm long  |

## Rutherford Morrison Tissue Forceps

Box joint

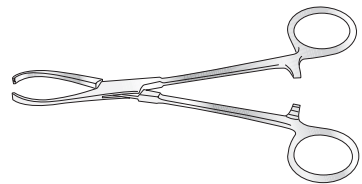

| Code      | Description           |
|-----------|-----------------------|
| SC-GI/283 | 4-5 teeth, 152mm long |

## Shaw Tissue Forceps

Box joint

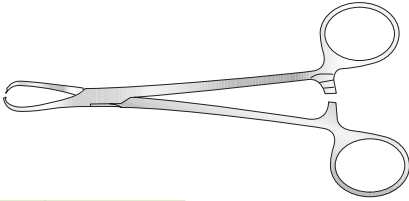

| Code      | Description           |
|-----------|-----------------------|
| SC-GI/458 | 1-2 teeth, 178mm long |



## Guys Gallabin Suture-Holding Forceps

Screw joint, angled flat blades

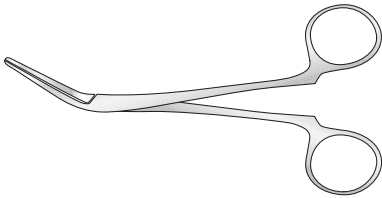

| Code       | Description |
|------------|-------------|
| SC-GI/450  | 125mm long  |
| SC-GI/4402 | 150mm long  |

## Russian Dissecting Forceps

With fenestrated end



| Code           | Description |
|----------------|-------------|
| SC-GI/SH-5503b | 150mm long  |
| SC-GI/SH-5503  | 200mm long  |
| SC-GI/403      | 230mm long  |
| SC-GI/SH-5503a | 250mm long  |



# Sponge Holding and Sterilising Forceps

## Rampléy Sponge Holding Forceps

Box joint, straight, serrated jaws

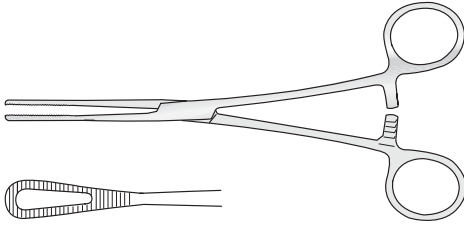

| Code      | Description |
|-----------|-------------|
| SC-GI/353 | 178mm long  |
| SC-GI/354 | 241mm long  |

## Lister Sinus Forceps

Box joint, serrated tip

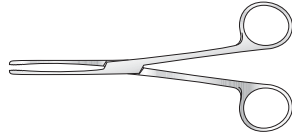

| Code      | Description |
|-----------|-------------|
| SC-GI/367 | 127mm long  |
| SC-GI/368 | 152mm long  |
| SC-GI/369 | 178mm long  |



## Foerster Sponge Holding Forceps

Box joint, straight, serrated jaws

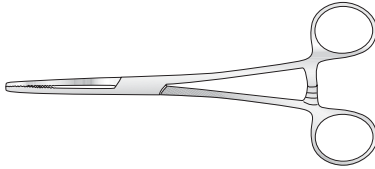

| Code       | Description |
|------------|-------------|
| SC-GI/354a | 178mm long  |



## Cheatle Sterilizer Forceps

Screw joint

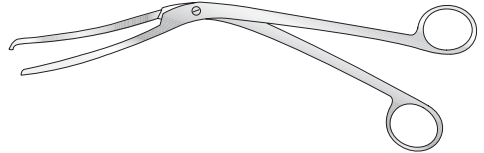

| Code      | Description |
|-----------|-------------|
| SC-GI/364 | 267mm long  |

## Harrison Bowl Steriliser Forceps

Screw joint, angled, double jaw

| Code      | Description |
|-----------|-------------|
| SC-GI/365 | 356mm long  |
| SC-GI/366 | 457mm long  |

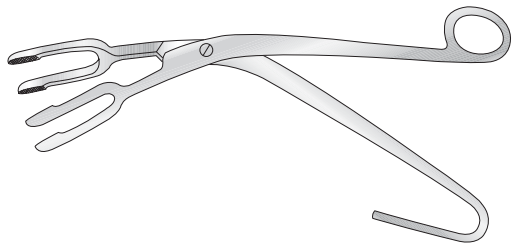

# Other Forceps

## Hunter Splinter Forceps

Serrated grooved pointed jaws



| Code      | Description |
|-----------|-------------|
| SC-GI/360 | 115mm long  |

## Michel Forceps

Box joint, double-ended, for inserting and removing clips stainless steel

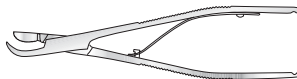

| Code      | Description |
|-----------|-------------|
| SC-GI/357 | 130mm long  |

## Michel Skin Holding Forceps

With magazine for Michel clips

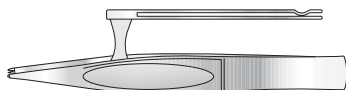

| Code      | Description           |
|-----------|-----------------------|
| SC-GI/358 | 1-2 teeth, 127mm long |

## Michel Clip Extracting Forceps

Box joint

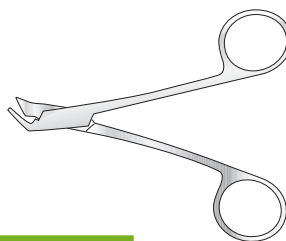

| Code      | Description |
|-----------|-------------|
| SC-GI/359 | 125mm long  |

## Childe Approximating Forceps

With magazine for Michel clips

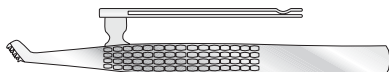

| Code      | Description |
|-----------|-------------|
| SC-GI/469 | 180mm long  |

## Robins Anchoring Forceps

140mm long

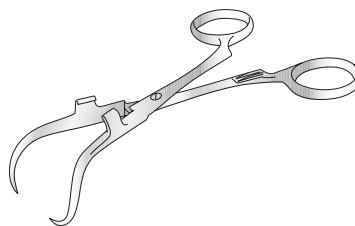

| Code       | Description                         |
|------------|-------------------------------------|
| SC-GI/453  | 5mm with holder for diathermy leads |
| SC-GI/453a | 13mm with holder for suction tubing |

# Premium Quality Stainless Steel Scissors

## Dressing Scissors



### Blunt/Blunt

#### Straight

| Code      | Description |
|-----------|-------------|
| SC-GI/133 | 130mm long  |
| SC-GI/136 | 146mm long  |
| SC-GI/139 | 165mm long  |

#### Curved

| Code      | Description |
|-----------|-------------|
| SC-GI/142 | 130mm long  |
| SC-GI/143 | 146mm long  |
| SC-GI/144 | 165mm long  |
| SC-GI/145 | 185mm long  |
| SC-GI/404 | 147mm long  |

With one serrated blade

### Blunt/Sharp

#### Straight

| Code      | Description |
|-----------|-------------|
| SC-GI/134 | 130mm long  |
| SC-GI/137 | 146mm long  |
| SC-GI/140 | 165mm long  |

### Sharp/Sharp

#### Straight

| Code      | Description |
|-----------|-------------|
| SC-GI/135 | 130mm long  |
| SC-GI/138 | 146mm long  |
| SC-GI/141 | 165mm long  |

#### Curved

| Code      | Description |
|-----------|-------------|
| SC-GI/146 | 130mm long  |

## Dressing Scissors, Left-Handed

With one black bow, 145mm long

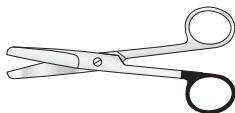

### Blunt/Blunt

| Code      | Description |
|-----------|-------------|
| SC-GI/192 | Straight    |
| SC-GI/193 | Curved      |

### Blunt/Sharp

| Code      | Description |
|-----------|-------------|
| SC-GI/194 | Straight    |
| SC-GI/195 | Curved      |

### Sharp/Sharp

| Code      | Description |
|-----------|-------------|
| SC-GI/196 | Straight    |
| SC-GI/197 | Curved      |

## Littler Dissecting Scissors

Fine pattern, with eye for suture



| Code       | Description |
|------------|-------------|
| SC-PL/001f | 115mm long  |

## Kilner Dissecting Scissors

Fine pattern



| Code       | Description |
|------------|-------------|
| SC-PL/001a | 115mm long  |

## Metzenbaum Scissors

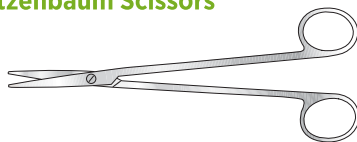

### Straight

| Code       | Description |
|------------|-------------|
| SC-GI/405  | 180mm long  |
| SC-GI/406  | 147mm long  |
| SC-GI/406a | 200mm long  |
| SC-GI/406b | 230mm long  |
| SC-GI/406c | 250mm long  |
| SC-GI/406d | 280mm long  |

### Curved

| Code       | Description |
|------------|-------------|
| SC-GI/407  | 185mm long  |
| SC-GI/408  | 147mm long  |
| SC-GI/408a | 200mm long  |
| SC-GI/408b | 230mm long  |
| SC-GI/408c | 250mm long  |
| SC-GI/408d | 280mm long  |

## Mayo Scissors



### Straight

| Code       | Description |
|------------|-------------|
| SC-GI/409  | 140mm long  |
| SC-GI/409a | 160mm long  |
| SC-GI/411  | 190mm long  |
| SC-GI/411a | 230mm long  |

### Curved

| Code       | Description |
|------------|-------------|
| SC-GI/410  | 140mm long  |
| SC-GI/410a | 160mm long  |
| SC-GI/412  | 190mm long  |
| SC-GI/412a | 230mm long  |

## Fergusson Scissors

Angled on flat

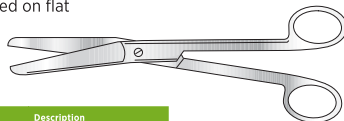

| Code      | Description |
|-----------|-------------|
| SC-GI/148 | 180mm long  |

## Paynes Suture Scissors

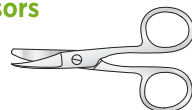

| Code      | Description |
|-----------|-------------|
| SC-GI/152 | 100mm long  |

## Ligature Stitch Scissors

Fine pattern

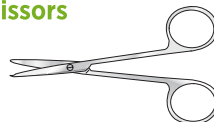

| Code      | Description |
|-----------|-------------|
| SC-GI/153 | 115mm long  |



## Lister Bandage Scissors

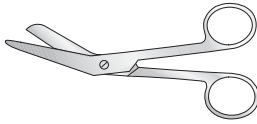

| Code      | Description |
|-----------|-------------|
| SC-GI/154 | 147mm long  |
| SC-GI/155 | 178mm long  |

## Lister Bandage Scissors

Angled, with probe end

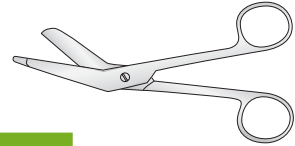

| Code      | Description |
|-----------|-------------|
| SC-GI/361 | 147mm long  |
| SC-GI/362 | 178mm long  |

## McIndoe Scissors

178mm long

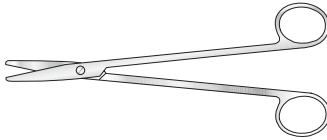

| Code        | Description      |
|-------------|------------------|
| SC-GI/149   | Straight         |
| SC-GI/150   | Curved on flat   |
| SC-GI/150sc | Supercut, curved |



## Thomas Strabismus Scissors

114mm long

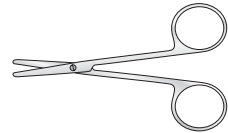

| Code      | Description |
|-----------|-------------|
| SC-OP/030 | Straight    |
| SC-OP/029 | Curved      |

## Heath Stitch Scissors

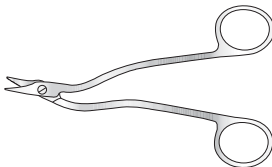

| Code      | Description |
|-----------|-------------|
| SC-GI/151 | 152mm long  |

## “Careless” Scissors

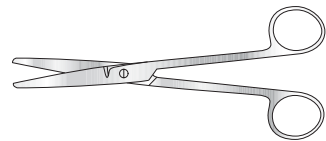

| Code      | Description |
|-----------|-------------|
| SC-GI/474 | 165mm long  |

## Tubing Scissors

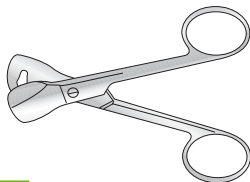

| Code      | Description |
|-----------|-------------|
| SC-GI/147 | 130mm long  |

## Utility Scissors



| Code      | Description |
|-----------|-------------|
| SC-GI/466 | 190mm long  |

# Tungsten Carbide Hard Insert Scissors

## Dressing Scissors

Tungsten carbide hard insert,  
blunt/blunt

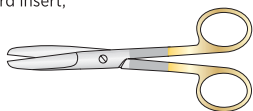

**Straight**

| Code      | Description |
|-----------|-------------|
| SC-GI/430 | 130mm long  |
| SC-GI/432 | 145mm long  |
| SC-GI/434 | 165mm long  |
| SC-GI/436 | 185mm long  |

**Curved**

| Code      | Description |
|-----------|-------------|
| SC-GI/431 | 130mm long  |
| SC-GI/433 | 145mm long  |
| SC-GI/435 | 165mm long  |

## Mayo Dressing Scissors

Tungsten carbide hard insert

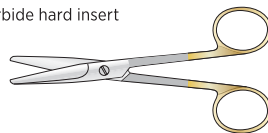

**Straight**

| Code       | Description |
|------------|-------------|
| SC-GI/419  | 140mm long  |
| SC-GI/419a | 160mm long  |
| SC-GI/421  | 190mm long  |
| SC-GI/421a | 230mm long  |

**Curved**

| Code       | Description |
|------------|-------------|
| SC-GI/420  | 140mm long  |
| SC-GI/420a | 160mm long  |
| SC-GI/422  | 190mm long  |
| SC-GI/422a | 230mm long  |

## Dressing Scissors

Tungsten carbide hard insert,  
blunt/sharp

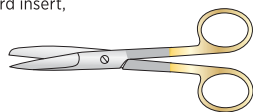

**Straight**

| Code      | Description |
|-----------|-------------|
| SC-GI/423 | 130mm long  |
| SC-GI/425 | 145mm long  |
| SC-GI/427 | 165mm long  |
| SC-GI/429 | 185mm long  |

**Curved**

| Code      | Description |
|-----------|-------------|
| SC-GI/424 | 130mm long  |
| SC-GI/426 | 145mm long  |
| SC-GI/428 | 165mm long  |

## Mayo-Harrington Dressing Scissors

Tungsten carbide hard insert

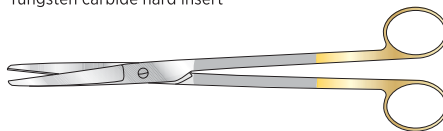

**230mm long**

| Code      | Description |
|-----------|-------------|
| SC-GI/417 | Straight    |
| SC-GI/418 | Curved      |

**200mm long**

| Code       | Description |
|------------|-------------|
| SC-GI/162a | Straight    |
| SC-GI/413b | Curved      |

## Dressing Scissors

Tungsten carbide hard insert sharp/sharp

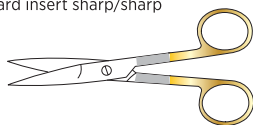

**Straight**

| Code      | Description |
|-----------|-------------|
| SC-GI/437 | 130mm long  |
| SC-GI/439 | 145mm long  |
| SC-GI/441 | 165mm long  |
| SC-GI/443 | 185mm long  |

**Curved**

| Code      | Description |
|-----------|-------------|
| SC-GI/438 | 130mm long  |
| SC-GI/440 | 145mm long  |
| SC-GI/442 | 165mm long  |

## Metzenbaum Scissors

Tungsten carbide hard insert

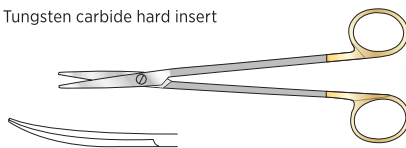

**230mm long**

| Code       | Description |
|------------|-------------|
| SC-GI/445  | 145mm long  |
| SC-GI/448  | 185mm long  |
| SC-GI/471a | 230mm long  |
| SC-GI/471b | 250mm long  |
| SC-GI/471c | 280mm long  |

**200mm long**

| Code       | Description |
|------------|-------------|
| SC-GI/446  | 145mm long  |
| SC-GI/449  | 185mm long  |
| SC-GI/449a | 200mm long  |
| SC-GI/449b | 230mm long  |
| SC-GI/449c | 250mm long  |
| SC-GI/449d | 280mm long  |

## Baby Metzenbaum Scissors

Tungsten carbide,  
hard insert, 145mm long

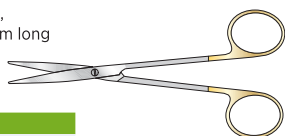

| Code       | Description |
|------------|-------------|
| SC-GI/445a | Straight    |
| SC-GI/446a | Curved      |

## Ligature Scissors

Tungsten carbide  
hard insert, curved

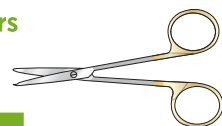

| Code      | Description |
|-----------|-------------|
| SC-GI/444 | 145mm long  |
| SC-GI/447 | 185mm long  |

# Tungsten Carbide Supercut Scissors

## Mayo Harrington Scissors

Supercut, tungsten carbide

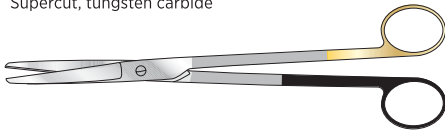

### 230mm long

| Code      | Description |
|-----------|-------------|
| SC-GI/162 | Straight    |
| SC-GI/413 | Curved      |

### 200mm long

| Code       | Description |
|------------|-------------|
| SC-GI/162b | Straight    |
| SC-GI/413b | Curved      |

## Mayo Scissors

Supercut, tungsten carbide

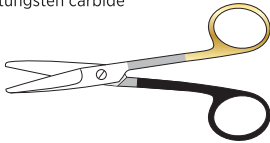

### Straight

| Code       | Description |
|------------|-------------|
| SC-GI/163  | 140mm long  |
| SC-GI/163a | 160mm long  |
| SC-GI/165  | 190mm long  |
| SC-GI/165a | 230mm long  |

### Curved

| Code       | Description |
|------------|-------------|
| SC-GI/164  | 140mm long  |
| SC-GI/164a | 160mm long  |
| SC-GI/166  | 190mm long  |
| SC-GI/166a | 230mm long  |

## Metzenbaum Dissecting Scissors

Supercut, tungsten carbide



### Straight

| Code         | Description |
|--------------|-------------|
| SC-GI/188tc  | 185mm long  |
| SC-GI/188tca | 200mm long  |
| SC-GI/188tcb | 230mm long  |
| SC-GI/188tcc | 250mm long  |
| SC-GI/188tcd | 280mm long  |

### Curved

| Code         | Description |
|--------------|-------------|
| SC-GI/191tc  | 147mm       |
| SC-GI/189tc  | 185mm       |
| SC-GI/186tca | 200mm       |
| SC-GI/188tcb | 230mm       |
| SC-GI/188tcc | 250mm       |
| SC-GI/188tcd | 280mm       |

## Dressing Scissors

Supercut, tungsten carbide

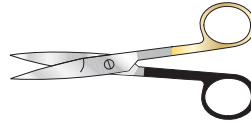

### Blunt/Blunt

#### Straight

| Code      | Description |
|-----------|-------------|
| SC-GI/174 | 130mm long  |
| SC-GI/176 | 145mm long  |
| SC-GI/178 | 165mm long  |
| SC-GI/180 | 185mm long  |

#### Curved

| Code       | Description |
|------------|-------------|
| SC-GI/175  | 130mm long  |
| SC-GI/177  | 145mm long  |
| SC-GI/179  | 165mm long  |
| SC-GI/180a | 185mm long  |

### Blunt/Sharp

#### Straight

| Code      | Description |
|-----------|-------------|
| SC-GI/167 | 130mm long  |
| SC-GI/169 | 145mm long  |
| SC-GI/171 | 165mm long  |
| SC-GI/173 | 185mm long  |

#### Curved

| Code       | Description |
|------------|-------------|
| SC-GI/168  | 130mm long  |
| SC-GI/170  | 145mm long  |
| SC-GI/172  | 165mm long  |
| SC-GI/173a | 185mm long  |

### Sharp/Sharp

#### Straight

| Code      | Description |
|-----------|-------------|
| SC-GI/181 | 130mm long  |
| SC-GI/183 | 145mm long  |
| SC-GI/185 | 165mm long  |
| SC-GI/187 | 185mm long  |

#### Curved

| Code       | Description |
|------------|-------------|
| SC-GI/182  | 130mm long  |
| SC-GI/184  | 145mm long  |
| SC-GI/186  | 165mm long  |
| SC-GI/187a | 185mm long  |



# Supercut Operating Scissors

**i** WITH TWO BLACK BOWS FOR IDENTIFICATION

## Dressing Scissors

Supercut, blunt/blunt

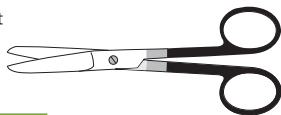

145mm long

| Code      | Description |
|-----------|-------------|
| SC-GI/160 | Straight    |
| SC-GI/161 | Curved      |

## Dressing Scissors

Supercut, blunt/sharp

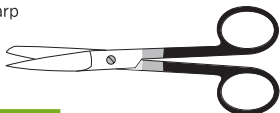

145mm long

| Code      | Description |
|-----------|-------------|
| SC-GI/156 | Straight    |
| SC-GI/157 | Curved      |

## Dressing Scissors

Supercut, sharp/sharp

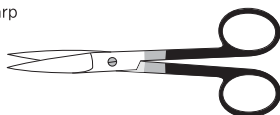

145mm long

| Code      | Description |
|-----------|-------------|
| SC-GI/158 | Straight    |
| SC-GI/159 | Curved      |

## Mayo Scissors

Supercut



Straight

| Code       | Description |
|------------|-------------|
| SC-GI/166a | 140mm long  |
| SC-GI/166e | 160mm long  |
| SC-GI/166b | 170mm long  |

Curved

| Code       | Description |
|------------|-------------|
| SC-GI/166c | 140mm long  |
| SC-GI/166f | 160mm long  |
| SC-GI/166d | 170mm long  |

## Boyd Scissors

Supercut, blunt/blunt

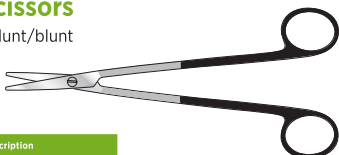

| Code       | Description |
|------------|-------------|
| SC-THO/047 | 180mm long  |

## Metzenbaum Dissecting Scissors

Supercut

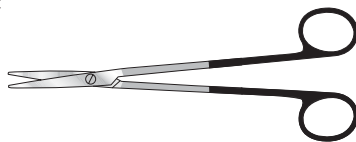

Straight (length)

| Code       | Description |
|------------|-------------|
| SC-GI/190  | 147mm       |
| SC-GI/188  | 185mm       |
| SC-GI/188a | 200mm       |
| SC-GI/188b | 230mm       |
| SC-GI/188c | 250mm       |
| SC-GI/188d | 280mm       |

Curved (length)

| Code       | Description |
|------------|-------------|
| SC-GI/191  | 147mm       |
| SC-GI/189  | 185mm       |
| SC-GI/186a | 200mm       |
| SC-GI/186b | 230mm       |
| SC-GI/186c | 250mm       |
| SC-GI/186d | 280mm       |

## Stevens Tenotomy Scissors

Supercut



Curved/blunt

| Code        | Description |
|-------------|-------------|
| SC-OP/424   | 114mm long  |
| SC-OP/424a  | 125mm long  |
| SC-OP/424gb | 135mm long  |

Curved/sharp

| Code       | Description |
|------------|-------------|
| SC-OP/425  | 114mm long  |
| SC-OP/425a | 140mm long  |
| SC-OP/425b | 160mm long  |

With cutout, 110mm long

| Code       | Description                |
|------------|----------------------------|
| SC-OP/426  | Straight/blunt, 114mm long |
| SC-OP/427  | Straight/sharp, 114mm long |
| SC-OP/427c | Straight/sharp, 180mm long |

Code

| Code       | Description    |
|------------|----------------|
| SC-OP/427a | Straight/blunt |
| SC-OP/427b | Curved/blunt   |

## Strabismus Scissors

Supercut

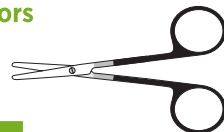

114mm long

| Code       | Description |
|------------|-------------|
| SC-GI/475  | Straight    |
| SC-GI/475a | Curved      |

## Iris Scissors

Supercut



114mm long

| Code       | Description |
|------------|-------------|
| SC-OP/476  | Straight    |
| SC-OP/476a | Curved      |

## Bruce Clarke Needle Holder

Screw joint

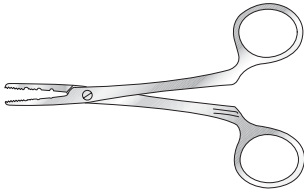

| Code      | Description |
|-----------|-------------|
| SC-GI/205 | 127mm long  |

## Lawrence Needle Holder

Fine jaw, 150mm long

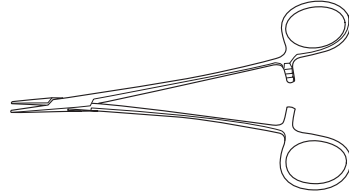

| Code       | Description          |
|------------|----------------------|
| SC-PL/012a |                      |
| SC-PL/012b | Tungsten carbide jaw |

## Crile-Wood Needle Holder

Straight, baby, fine

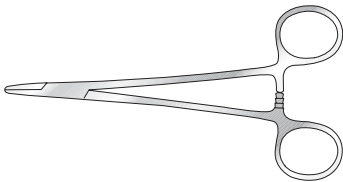

| Code      | Description |
|-----------|-------------|
| SC-GI/199 | 150mm long  |

## Needle Holder

Surgical Holdings pattern, box joint, lightweight, with curved plain jaws and one offset bow for thumb

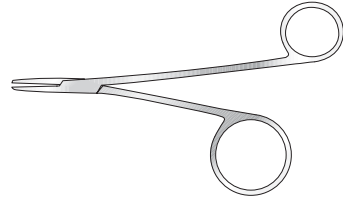

| Code      | Description |
|-----------|-------------|
| SC-GI/209 | 152mm long  |

## Kilner Needle Holder

Box joint, cross-serrated jaw

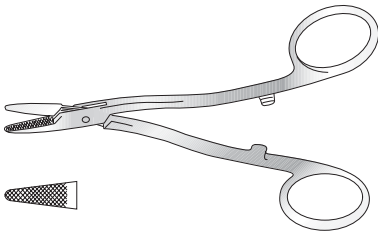

| Code      | Description |
|-----------|-------------|
| SC-GI/200 | 165mm long  |
| SC-GI/201 | 133mm long  |

## MacPhail Needle Holder

Screw joint, with one copper jaw

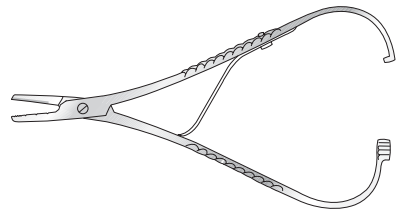

| Code      | Description |
|-----------|-------------|
| SC-GI/206 | 159mm long  |
| SC-GI/207 | 178mm long  |
| SC-GI/208 | 209mm long  |

# Needle Holders

## Mathieu Needle Holder

Screw joint

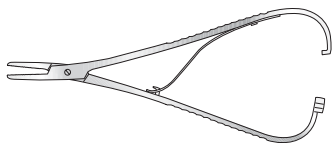

| Code      | Description |
|-----------|-------------|
| SC-GI/210 | 172mm long  |
| SC-GI/211 | 209mm long  |
| SC-GI/212 | 243mm long  |

## Naughton Morgan Needle Holder

Box joints, cross serrated jaws

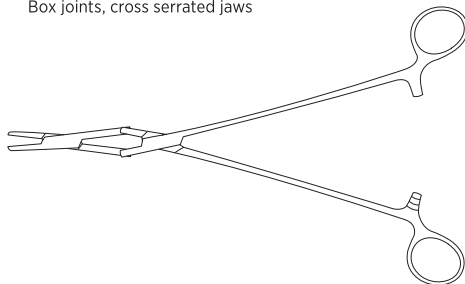

Tungsten carbide

| Code      | Description |
|-----------|-------------|
| SC-GI/399 | 185mm long  |
| SC-GI/400 | 254mm long  |

| Code      | Description |
|-----------|-------------|
| SC-GI/401 | 185mm long  |
| SC-GI/402 | 254mm long  |

## Mayo Needle Holder

Box joint, straight

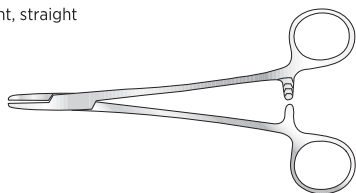

Wide cross serrated jaws

| Code      | Description |
|-----------|-------------|
| SC-GI/224 | 159mm long  |
| SC-GI/398 | 203mm long  |

Narrow cross serrated jaws

| Code      | Description |
|-----------|-------------|
| SC-GI/225 | 159mm long  |

## Rochester-Mayo Needle Holder

Screw joint

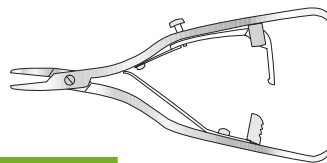

| Code      | Description |
|-----------|-------------|
| SC-GI/213 | 178mm long  |



WITH TWO GOLD BOWS  
FOR IDENTIFICATION

# Tungsten Carbide Needle Holders

## Berry Needle Holder/Wire Twister

Tungsten carbide jaws

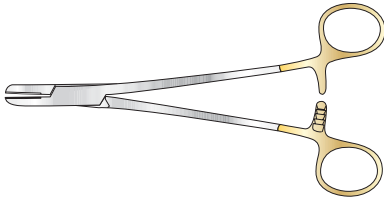

| Code      | Description |
|-----------|-------------|
| SC-GI/467 | 200mm long  |

## Finochietto Needle Holder

Tungsten carbide jaws

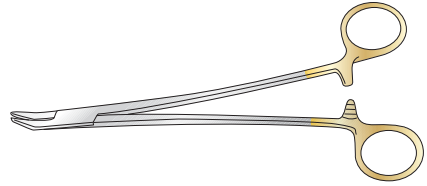

| Code      | Description |
|-----------|-------------|
| SC-GI/222 | 215mm long  |
| SC-GI/223 | 265mm long  |

## Crile-Wood Needle Holder

Tungsten carbide insert, box joint, satin finish, straight

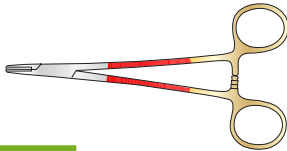

| Code      | Description |
|-----------|-------------|
| SC-GI/217 | 159mm long  |
| SC-GI/218 | 178mm long  |
| SC-GI/198 | 150mm long  |

## Halsey Needle Holder

Tungsten carbide insert, box joint, satin finish, straight

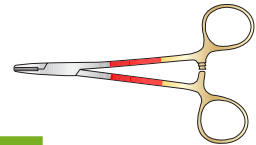

| Code      | Description |
|-----------|-------------|
| SC-GI/220 | 127mm long  |

## Derf Needle Holder

Tungsten carbide insert

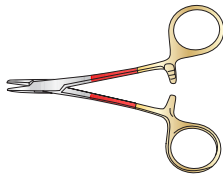

| Code           | Description |
|----------------|-------------|
| SC-GI/BUPHF002 | 115mm long  |

## Kilner Needle Holder

Tungsten carbide insert

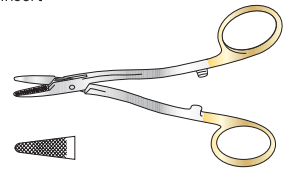

| Code      | Description |
|-----------|-------------|
| SC-GI/221 | 140mm long  |

# Tungsten Carbide Needle Holders

**i** WITH TWO GOLD BOWS  
FOR IDENTIFICATION

## Masing Needle Holder

Tungsten carbide insert,  
one angled bow

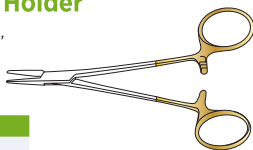

| Code       | Description |
|------------|-------------|
| SC-GI/009R | 130mm long  |

## Nievert Needle Holder

Tungsten carbide insert, box joint,  
satin finish, straight

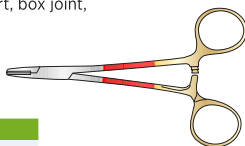

| Code      | Description |
|-----------|-------------|
| SC-GI/219 | 127mm long  |

## DeBakey Needle Holder

250mm long

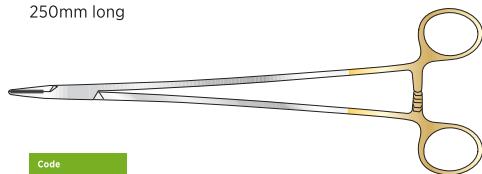

| Code         |
|--------------|
| THO/SC-5642a |

## Ryder Needle Holder

Tungsten carbide insert, box joint, satin finish, straight

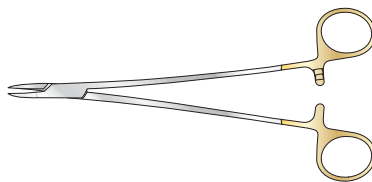

### 0.2mm jaw pitch

| Code           | Description |
|----------------|-------------|
| SC-GI/SH-5197a | 135mm long  |
| SC-GI/SH-5197b | 155mm long  |
| SC-GI/SH-5197c | 175mm long  |
| SC-GI/SH-5197d | 210mm long  |

### 0.4mm jaw pitch

| Code           | Description |
|----------------|-------------|
| SC-GI/SH-5198a | 135mm long  |
| SC-GI/SH-5198b | 155mm long  |
| SC-GI/SH-5198c | 175mm long  |
| SC-GI/SH-5198d | 210mm long  |

## Sarot Needle Holder

Diamond jaw, tungsten carbide, gold plated bows

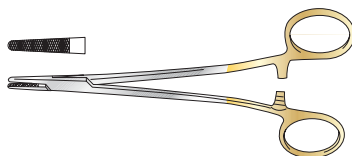

| Code      | Description |
|-----------|-------------|
| SC-GI/451 | 181mm long  |

## Mayo-Hegar Needle Holder

Tungsten carbide insert, box joint, satin finish, straight

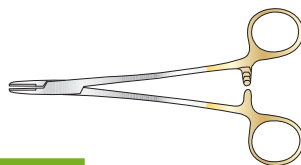

| Code      | Description |
|-----------|-------------|
| SC-GI/472 | 130mm long  |
| SC-GI/214 | 159mm long  |
| SC-GI/215 | 178mm long  |
| SC-GI/216 | 209mm long  |

LONGER SIZES AVAILABLE

# Combined Scissor and Needle Holders

## Olsen-Hegar Scissor/Needle Holder

With tungsten carbide insert

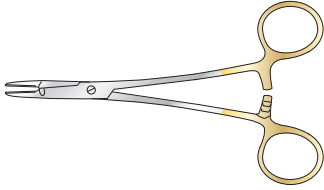

| Code      | Description |
|-----------|-------------|
| SC-GI/229 | 147mm long  |
| SC-GI/230 | 165mm long  |

## Olsen-Hegar Scissor/Needle Holder

Screw joint

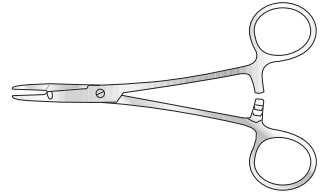

| Code      | Description |
|-----------|-------------|
| SC-GI/226 | 140mm long  |
| SC-GI/227 | 165mm long  |
| SC-GI/228 | 190mm long  |

## Gillies Scissor/Needle Holder

Right-hand, with tungsten carbide insert

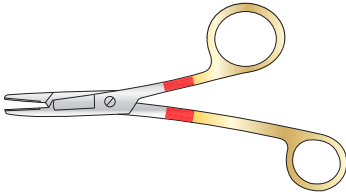

| Code      | Description |
|-----------|-------------|
| SC-GI/235 | 158mm long  |

## Gillies Scissor/Needle Holder

Heavy pattern, 158mm long

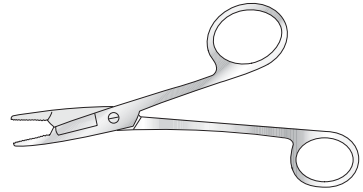

| Code      | Description |
|-----------|-------------|
| SC-GI/233 | Right-hand  |
| SC-GI/234 | Left-hand   |

## Gillies Scissor/Needle Holder

158mm long

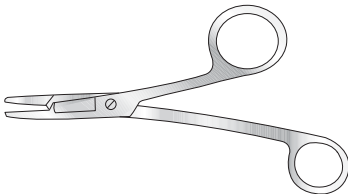

| Code      | Description |
|-----------|-------------|
| SC-GI/231 | Right-hand  |
| SC-GI/232 | Left-hand   |

## Foster Gillies Scissor/Needle Holder

Fine pattern



| Code      | Description |
|-----------|-------------|
| SC-GI/236 | 127mm long  |

# Bag and Towel Clips

## Spring Clip

Serrated pattern, stainless steel, for fixing slings to leg splints, also for towel clipping

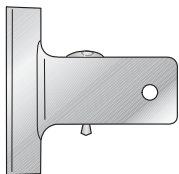

| Code      | Description |
|-----------|-------------|
| SC-GI/344 | 63mm wide   |

## Spring Bag Clip

Serrated



| Code      | Description |
|-----------|-------------|
| SC-GI/345 | 26mm wide   |

## Jones Towel Clip

Superior quality spring forcep type

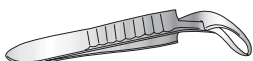

| Code      | Description |
|-----------|-------------|
| SC-GI/346 | 89mm long   |

## Shardles Towel Clip

Spring curved, cross action



| Code      | Description |
|-----------|-------------|
| SC-GI/347 | 77mm long   |

## Backhaus Towel Clip

Superior quality, box joint



| Code       | Description |
|------------|-------------|
| SC-GI/348  | 89mm long   |
| SC-GI/348a | 102mm long  |
| SC-GI/349  | 130mm long  |

## Moynihan Towel Clip

Screw joint, 2-2 teeth, for sides of incision

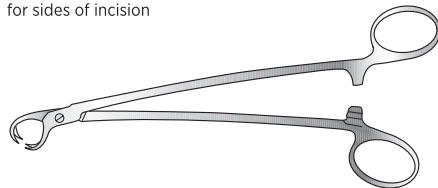

| Code      | Description |
|-----------|-------------|
| SC-GI/470 | 191mm long  |

## Ball and Socket Towel Forceps

Box joint

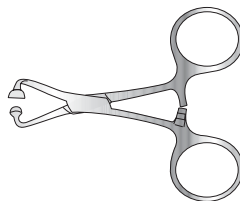

| Code      | Description |
|-----------|-------------|
| SC-GI/350 | 89mm long   |
| SC-GI/351 | 115mm long  |
| SC-GI/352 | 140mm long  |

## Goligher Retractor

Complete with 2 centre blades:  
1 x 90mm wide x 50mm deep  
1 x 90mm wide x 90mm deep

and 2 pairs of lateral blades:  
1 pair 25mm wide x 45mm deep  
1 pair 50mm wide x 90mm deep

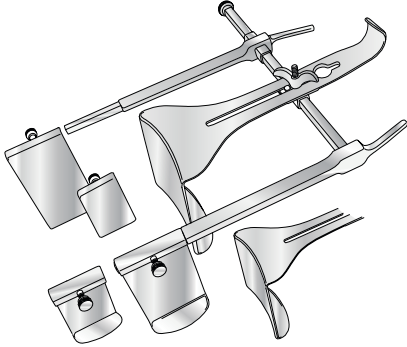

**Code**

SC-GI/305

## Balfour Abdominal Retractor

Trivalve, frame 203mm

**Child**

102mm opening, 51mm deep lateral blades,  
38mm deep centre blade

**Adult**

178mm opening, 64mm deep lateral blades,  
44mm deep centre blade

**Extra large**

178mm opening, 102mm deep lateral blades,  
108mm deep centre blade

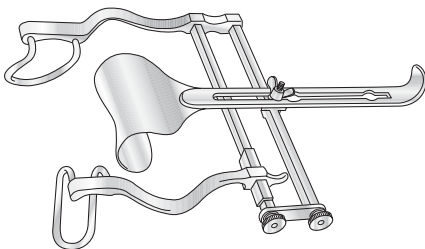

**Code**      **Description**

SC-GI/373      Child

SC-GI/374      Adult

SC-GI/375      Extra large

## Miles Retractor

Complete with 2 centre blades:  
1 x 90mm wide x 50mm deep  
1 x 90mm wide x 75mm deep

and 2 pairs of lateral blades:  
1 pair 80mm wide x 35mm deep  
1 pair 80mm wide x 75mm deep

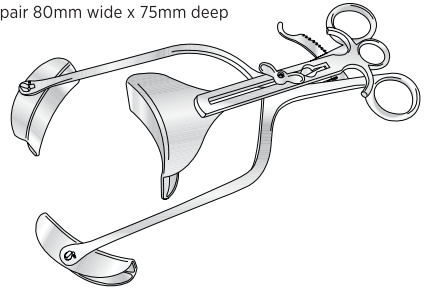

**Code**      **Description**

SC-GI/376      340mm long

OTHER BLADE SIZES AVAILABLE

## Balfour Abdominal Retractor

Bivalve, baby

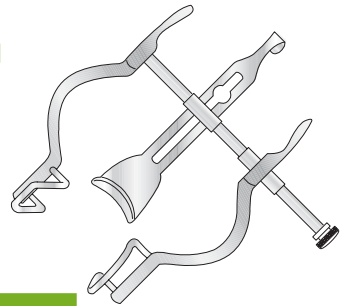

**Code**      **Description**

SC-GI/372      Fully open 89mm

## Berkeley Abdominal Retractor

Parallel action

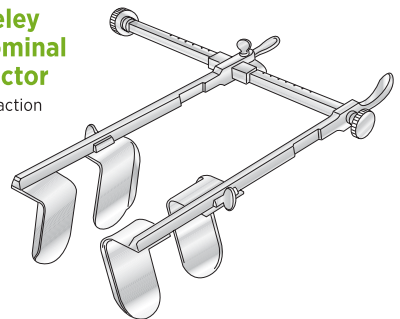

**Code**      **Description**

SC-GI/461      Blades 35mm x 60mm deep, 215mm long



# Turner Warwick Retractors

## Turner Warwick Universal Self Retaining Retractor

| Code        | Description                                    |
|-------------|--|
| SC-GI/520   | With frames A/B/C/D and blades A/B/C/D/E/F/K/L |
| SC-GI/521-A | Circular frame A only 178mm                    |
| SC-GI/521-B | Circular frame B only 229mm                    |
| SC-GI/521-C | Circular frame C only 305mm                    |
| SC-GI/521-D | Oval frame D only 475mm x 330mm                |
| SC-GI/521-E | Oval frame E only 370mm x 300mm                |

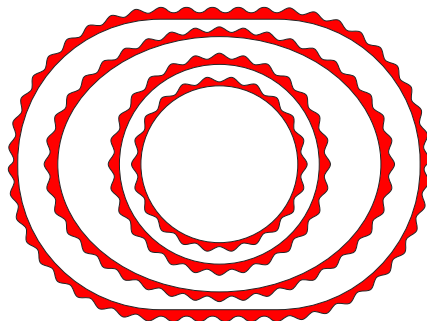

## Turner Warwick Needleholder with Tungsten Carbide Jaws

Curved shanks with one short bow

| Code     | Description |
|----------|-------------|
| SH-5835  | 230mm long  |
| SH-5835A | 200mm long  |

### Blade A

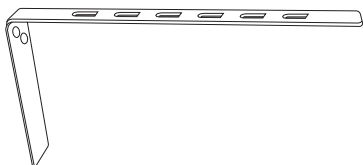

| Code        | Description              |
|-------------|--------------------------|
| SC-GI/522-A | Blade only - 19mm x 76mm |

### Blade B

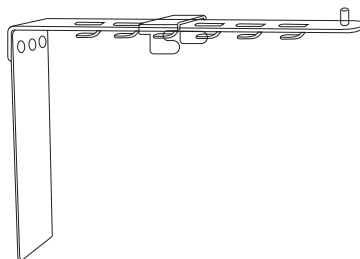

| Code        | Description               |
|-------------|---------------------------|
| SC-GI/522-B | Blade only - 38mm x 102mm |

### Blade C

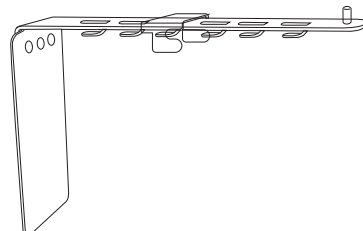

| Code        | Description              |
|-------------|--------------------------|
| SC-GI/522-C | Blade only - 57mm x 89mm |

### Blade D

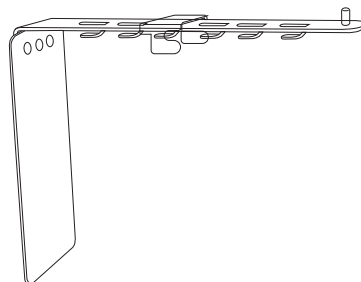

| Code        | Description               |
|-------------|---------------------------|
| SC-GI/522-D | Blade only - 57mm x 114mm |

## Blade E



| Code        | Description   |
|-------------|---|
| SC-GI/522-E | Blade only - curved stainless steel blade 51mm x 38mm |

## Blade F

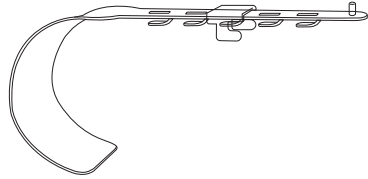

| Code        | Description   |
|-------------|---|
| SC-GI/522-F | Blade only - curved stainless steel blade 76mm x 60mm |

## Blade G

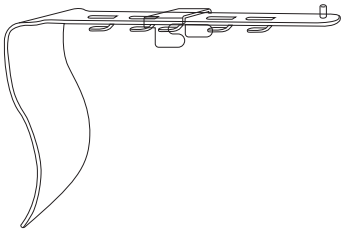

| Code        | Description   |
|-------------|---|
| SC-GI/522-G | Blade only - flat stainless steel blade 89mm x 60mm |

## Blade J



| Code        | Description                         |
|-------------|-------------------------------------|
| SC-GI/522-J | Blade only - single hook, 13mm deep |

## Blade K

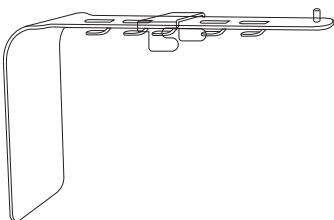

| Code        | Description                             |
|-------------|---|
| SC-GI/522-K | Blade only - flat with clip 55mm x 90mm |

## Blade L

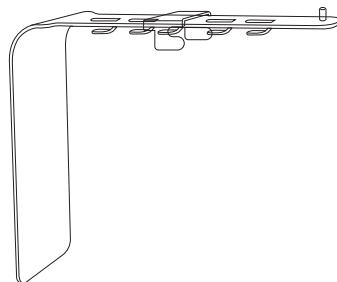

| Code        | Description                              |
|-------------|--|
| SC-GI/522-L | Blade only - flat with clip 55mm x 120mm |

# Retractors

## Collin Retractor

110mm fully open, 235mm long

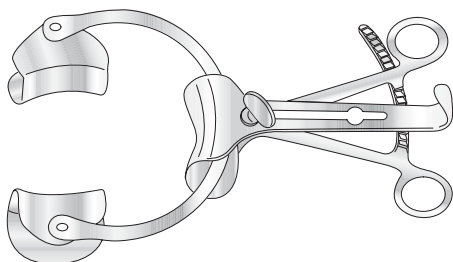

| Code       | Description   |
|------------|---|
| SC-GI/322  | Complete with centre blade 55 x 40mm and one pair of blades 38mm x 60mm |
| SC-GI/322a | Without centre blade  |

## Gelpi Retractor

Self retaining

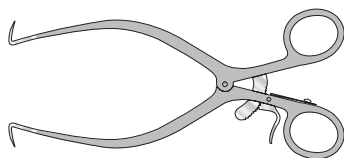

| Code       | Description |
|------------|-------------|
| SC-GY/013a | 140mm long  |
| SC-GY/013b | 178mm long  |

## Joll Thyroid Retractor

Self retaining, with lock-in nut

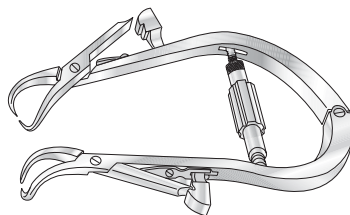

| Code      | Description |
|-----------|-------------|
| SC-GI/363 | 152mm long  |

## Gossett Abdominal Retractor

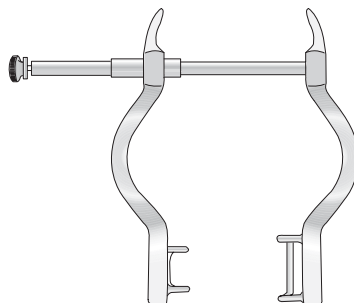

| Code      | Description                  |
|-----------|------------------------------|
| SC-GI/303 | Large, fully open 185mm long |
| SC-GI/304 | Small, fully open 95mm long  |

## Pozzi Abdominal Retractors

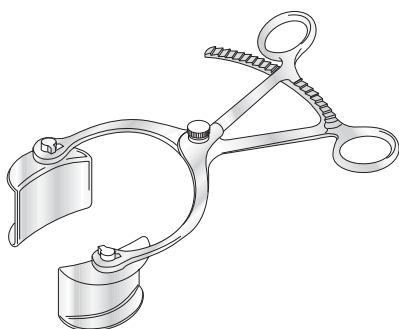

| Code      | Description                                   |
|-----------|---|
| SC-GI/370 | Swivel blades: 38 x 60mm, bivalve, 254mm long |

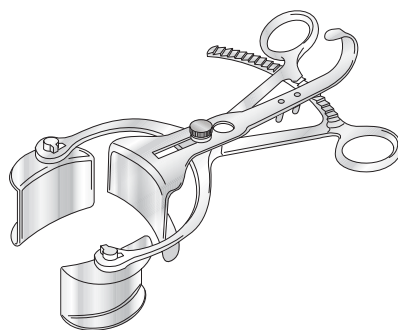

| Code      | Description                                    |
|-----------|--|
| SC-GI/371 | Swivel blades: 38 x 59mm, trivalve, 203mm long |

## Bowlby Dilator

Curved

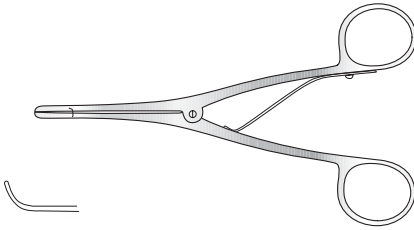

| Code      | Description |
|-----------|-------------|
| SC-GI/495 | 145mm long  |

## Travers Retractor

Self retaining with internal rack, 210mm long

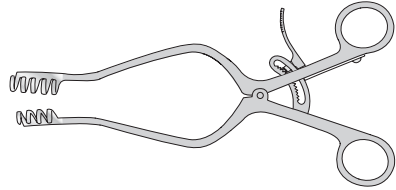

| Code      | Description                  |
|-----------|------------------------------|
| SC-GI/323 | 4 x 5 teeth, 95mm fully open |

## Irwin Retractor

Self retaining, with cam rack, 4 x 4 teeth

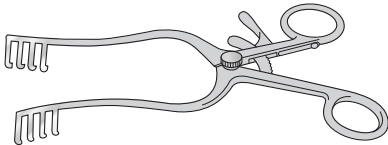

| Code      | Description |
|-----------|-------------|
| SC-GI/324 | 178mm long  |

## West Retractor

Self retaining, 140mm long

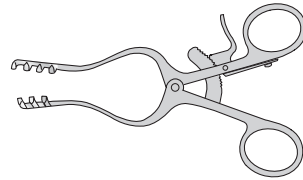

| Code        | Description                                 |
|-------------|---|
| SC-GI/326   | 3 x 4 teeth, 60mm fully open                |
| SC-GI/326cr | 3 x 4 teeth, 60mm fully open, with cam rack |

## Norfolk and Norwich Retractor

4 x 5 teeth 50mm blades x 223mm long

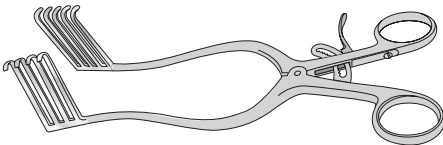

| Code      | Description   |
|-----------|---------------|
| SC-GI/325 | Standard rack |

## Weitlander Retractor

3-4 teeth

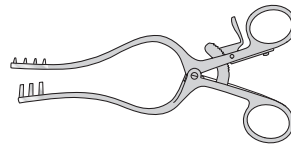

135mm long

| Code       | Description      |
|------------|------------------|
| SC-GI/496  | Blunt            |
| SC-GI/496a | Sharp            |
| SC-GI/496b | Sharp, 2-3 teeth |
| SC-GI/496c | Blunt, 2-3 teeth |

165mm long

| Code       | Description |
|------------|-------------|
| SC-GI/497  | Blunt       |
| SC-GI/497a | Sharp       |

# Retractors

## Kocher Retractor

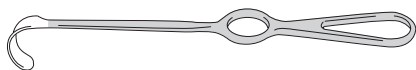

230mm long

| Code      | Description     |
|-----------|-----------------|
| SC-GI/378 | 36 x 20mm blade |

250mm long

| Code       | Description     |
|------------|-----------------|
| SC-GI/378a | 67 x 25mm blade |
| SC-GI/378b | 80 x 42mm blade |
| SC-GI/378c | 80 x 50mm blade |
| SC-GI/378d | 80 x 60mm blade |

## Kocher Langenbeck Retractor

215mm long



| Code        | Description     |
|-------------|-----------------|
| SC-GI/336sp | 25 x 6mm blade  |
| SC-GI/379a  | 35 x 8mm blade  |
| SC-GI/379b  | 35 x 11mm blade |
| SC-GI/379c  | 35 x 15mm blade |
| SC-GI/357sp | 41 x 11mm blade |

| Code            | Description     |
|-----------------|-----------------|
| SC-THD/cutsp015 | 55 x 11mm blade |
| SC-GI/379d      | 70 x 15mm blade |
| SC-GI/379e      | 80 x 12mm blade |
| SC-GI/379f      | 80 x 16mm blade |

## Langenbeck Retractor

Single ended

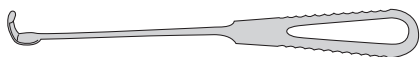

| Code        | Description       |
|-------------|-------------------|
| SC-GI/336   | Blade 22mm x 6mm  |
| SC-GI/337   | Blade 45mm x 13mm |
| SC-GI/337a  | Blade 65mm x 13mm |
| SC-GI/338a  | Blade 75mm x 25mm |
| SC-GI/338a1 | Blade 65mm x 25mm |

## Landon Retractor

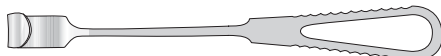

| Code      | Description |
|-----------|-------------|
| SC-GI/494 | 230mm       |



## Canny Ryall Navy Retractor

Double-ended, with one single hook blade 5mm wide, and one fenestrated blade

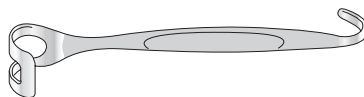

| Code       | Description                             |
|------------|---|
| SC-GI/343  | Fenestrated blade 16mm wide, 190mm long |
| SC-GI/343a | Fenestrated blade 19mm wide, 190mm long |
| SC-GI/343b | Fenestrated blade 25mm wide, 220mm long |
| SC-GI/343c | Fenestrated blade 30mm wide, 220mm long |

## Canny Ryall Army Retractor

Double prong, 13mm wide, 165mm long



| Code       | Description      |
|------------|------------------|
| SC-GI/342  | Large, 19mm wide |
| SC-GI/342a | Small, 11mm wide |



## Czerny Retractor

Double ended

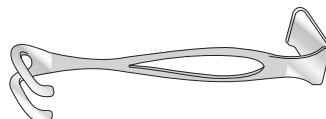

| Code      | Description |
|-----------|-------------|
| SC-GI/341 | 171mm long  |

## Lane Retractor

Double ended blade, 229mm long

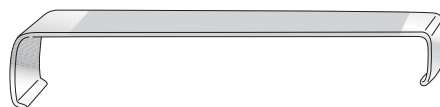

| Code      | Description      |
|-----------|------------------|
| SC-GI/339 | 13mm x 19mm wide |
| SC-GI/340 | 25mm x 32mm wide |

## Morris Retractor

Single blade, 229mm long

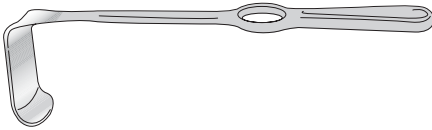

| Code      | Description |
|-----------|-------------|
| SC-GI/330 | 38 x 51mm   |
| SC-GI/331 | 51 x 51mm   |
| SC-GI/332 | 64 x 51mm   |

## Morris Retractor

Double ended, 216mm long



| Code      | Description             |
|-----------|-------------------------|
| SC-GI/327 | 32 x 51mm and 38 x 51mm |
| SC-GI/328 | 44 x 51mm and 51 x 51mm |
| SC-GI/329 | 64 x 51mm and 38 x 51mm |

## Moynihan Retractor



| Code      | Description                               |
|-----------|---|
| SC-GI/462 | Single ended, blade 13 x 22mm, 215mm long |

## Deaver Abdominal Retractors



| Code      | Description                    |
|-----------|--------------------------------|
| SC-GI/306 | Set of 5, 315mm overall length |
| SC-GI/307 | 25mm wide                      |
| SC-GI/308 | 25mm wide                      |
| SC-GI/309 | 38mm wide                      |
| SC-GI/310 | 51mm wide                      |
| SC-GI/311 | 76mm wide                      |

## Elliot (Modified Deaver) Retractor



| Code       | Description      |
|------------|------------------|
| SC-GI/308M | With flat handle |

## Dyball and Lock Retractor

For liver

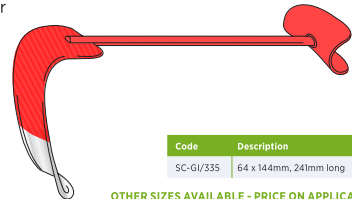

| Code      | Description            |
|-----------|------------------------|
| SC-GI/335 | 64 x 144mm, 241mm long |

OTHER SIZES AVAILABLE - PRICE ON APPLICATION

## Deaver Abdominal Retractors

With round handles

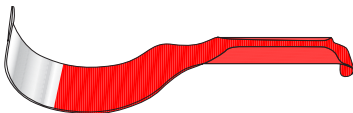

| Code      | Description                    |
|-----------|--------------------------------|
| SC-GI/312 | Set of 5, 305mm overall length |
| SC-GI/313 | 25mm wide                      |
| SC-GI/314 | 25mm wide                      |
| SC-GI/315 | 38mm wide                      |
| SC-GI/316 | 51mm wide                      |
| SC-GI/317 | 76mm wide                      |

## Kelly Retractor Blade

267mm long

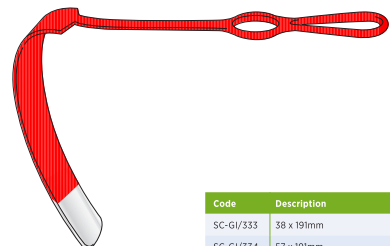

| Code      | Description |
|-----------|-------------|
| SC-GI/333 | 38 x 191mm  |
| SC-GI/334 | 57 x 191mm  |

# Retractors

## Durham Retractor

With fenestrated blade, 216mm long

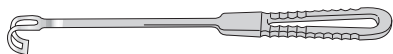

| Code      | Description |
|-----------|-------------|
| SC-GI/300 | 10mm wide   |
| SC-GI/301 | 14mm wide   |
| SC-GI/302 | 20mm wide   |

## Ballance (Volkman) Retractor

203mm long



### Sharp

| Code       | Description |
|------------|-------------|
| SC-GI/463  | 1 prong     |
| SC-GI/463a | 2 prong     |
| SC-GI/463b | 3 prong     |
| SC-GI/463c | 4 prong     |
| SC-GI/463d | 6 prong     |

### Blunt

| Code       | Description |
|------------|-------------|
| SC-GI/463e | 1 prong     |
| SC-GI/463f | 2 prong     |
| SC-GI/463g | 3 prong     |
| SC-GI/463h | 4 prong     |
| SC-GI/463i | 6 prong     |

## Volkman Retractor



| Code       | Description       |
|------------|-------------------|
| SC-OR/400  | Sharp, 220mm long |
| SC-OR/400a | Blunt, 220mm long |
| SC-OR/400b | Sharp, 245mm long |

## Kilner Retractor

Double ended, cat's paw



| Code      | Description |
|-----------|-------------|
| SC-PL/056 | 152mm long  |

## Kocher Retractor



| Code        | Description       |
|-------------|-------------------|
| SC-OR/N036c | Sharp, 205mm long |
| SC-OR/N036  | Sharp, 220mm long |
| SC-OR/N036b | Blunt, 220mm long |

## Senn-Miller Retractor

170mm long



| Code       |
|------------|
| SC-SH/5881 |

## Single Hook Retractor

Sharp



| Code         | Description     |
|--------------|-----------------|
| SC-GI/SH5671 | 152mm long      |
| SC-PL/065b   | Half size, fine |

## Gillies Skin Hook

Solid handle, 190mm long



| Code       | Description     |
|------------|-----------------|
| SC-PL/065a | Standard, fine  |
| SC-PL/065b | Half size, fine |

# Dissectors and Probes

## MacDonald Dissector Double Ended



| Code      | Description |
|-----------|-------------|
| SC-GI/285 | 191mm long  |

## Probe, Sinus Silver



| Code      | Description |
|-----------|-------------|
| SC-GI/464 | 152mm long  |

## Brodie Director Probe Ended, Silver Plated



| Code      | Description |
|-----------|-------------|
| SC-GI/286 | 165mm long  |

## Probe, Fish Tail Silver Plated



| Code      | Description |
|-----------|-------------|
| SC-GI/293 | 127mm long  |
| SC-GI/294 | 152mm long  |
| SC-GI/295 | 203mm long  |
| SC-GI/296 | 254mm long  |

## Watson Cheyne Dissector

Fine, double-ended, with probe end



| Code       | Description |
|------------|-------------|
| SC-GI/287  | 127mm long  |
| SC-GI/288  | 191mm long  |
| SC-GI/288a | 230mm long  |
| SC-GI/288b | 255mm long  |

## Jobson Horne Probe Dressing (Aural)

With one flat tapered end, serrated edge and one small ring end, stainless steel



| Code      | Description |
|-----------|-------------|
| SC-GI/297 | 140mm long  |
| SC-GI/298 | 178mm long  |

## Probe, Malleable Silver Plated



| Code       | Description |
|------------|-------------|
| SC-GI/289a | 127mm long  |
| SC-GI/289  | 152mm long  |
| SC-GI/290  | 178mm long  |
| SC-GI/291  | 203mm long  |
| SC-GI/292  | 255mm long  |
| SC-GI/292a | 305mm long  |



# Miscellaneous

## Aneurysm Needle

Small, for infusions



| Code       | Description |
|------------|-------------|
| SC-GI/472a | 146mm long  |

## Syme Aneurysm Needle



| Code      | Description |
|-----------|-------------|
| SC-GI/473 | 165mm long  |

## Ring Cutter

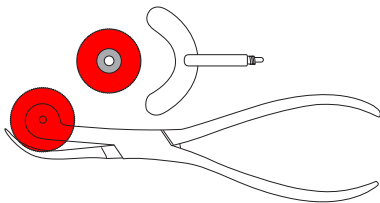

| Code       | Description                    |
|------------|--------------------------------|
| SC-GI/452  | Circular saw blade, 165mm long |
| SC-GI/452a | Spare blade                    |

## Mayo Instrument Pin

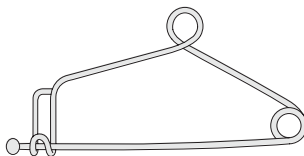

| Code      | Description |
|-----------|-------------|
| SC-GI/355 | 102mm long  |
| SC-GI/356 | 152mm long  |

## Baron Scalpel Handle

130mm long



| Code      | Description |
|-----------|-------------|
| SC-PM/003 | No 3        |
| SC-PM/004 | No 4        |

## Scalpel Handle

127mm long



| Code       | Description |
|------------|-------------|
| SC-PM/007  | No 3        |
| SC-PM/008  | No 4        |
| SC-PM/008a | No 4 L      |
| SC-PM/001a | No 7        |

## Kidney Dish

Stainless steel

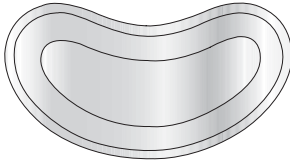

| Code      | Description |
|-----------|-------------|
| SC-GI/380 | 152mm       |
| SC-GI/381 | 203mm       |
| SC-GI/382 | 254mm       |
| SC-GI/383 | 305mm       |

## Cheatele Jar

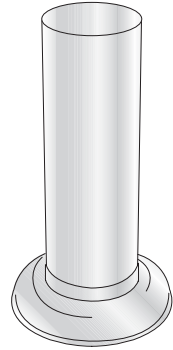

| Code      | Description                   |
|-----------|-------------------------------|
| SC-GI/397 | Stainless steel, 203mm x 50mm |

## Lotion Bowl

Without lid, stainless steel

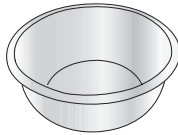

| Code      | Description |
|-----------|-------------|
| SC-GI/384 | 102mm       |
| SC-GI/385 | 152mm       |
| SC-GI/386 | 203mm       |
| SC-GI/387 | 254mm       |
| SC-GI/388 | 305mm       |

## Measuring Jug



| Code      | Description      |
|-----------|------------------|
| SC-GI/395 | 1 litre capacity |

## Instrument Tray

Stainless steel

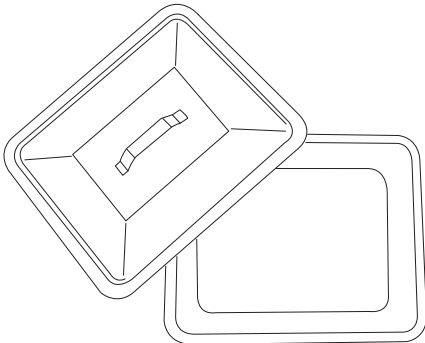

| Code      | Description                   |
|-----------|-------------------------------|
| SC-GI/389 | 254 x 203 x 50mm              |
| SC-GI/390 | Lid only for 254 x 203 x 50mm |
| SC-GI/391 | 305 x 254 x 50mm              |
| SC-GI/392 | Lid only for 305 x 254 x 50mm |
| SC-GI/393 | 356 x 305 x 50mm              |
| SC-GI/394 | Lid only for 356 x 305 x 50mm |

## Petri Dish



| Code         | Description                      |
|--------------|----------------------------------|
| SC-SH/002149 | 100mm, stainless steel, with lid |

## Gallipot

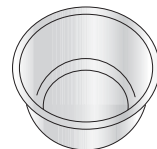

| Code      | Description           |
|-----------|-----------------------|
| SC-GI/396 | Stainless steel, 63mm |



**KOLAXO**  
INSTRUMENTS

 Factory #733, Quaid-e-Azam Industrial Area, Lahore

 [inquiry@kolaxoinstruments.com](mailto:inquiry@kolaxoinstruments.com)

 [www.kolaxoinstruments.com](http://www.kolaxoinstruments.com)